

# USER MANUAL

# Probler P2 Elite

## *Dispense Gun*

**For use with non-flammable foam and polyurea.  
Not for use in explosive atmospheres.**

**90-110 psi (0.62-0.76 MPa, 6.2-7.6 bar) Air Inlet Pressure Range  
3200 psi (22 MPa, 220 bar) Maximum Static Fluid Pressure**



#### **Important Safety Instructions**

Read all warnings and instructions in this manual. Save these instructions.

Models:  
GCP3RA  
GCP3R0  
GCP3R1  
GCP3R2  
GCP3R3  
GCP3R4  
GCP3R5

US Patent 6,796,461  
7,527,172

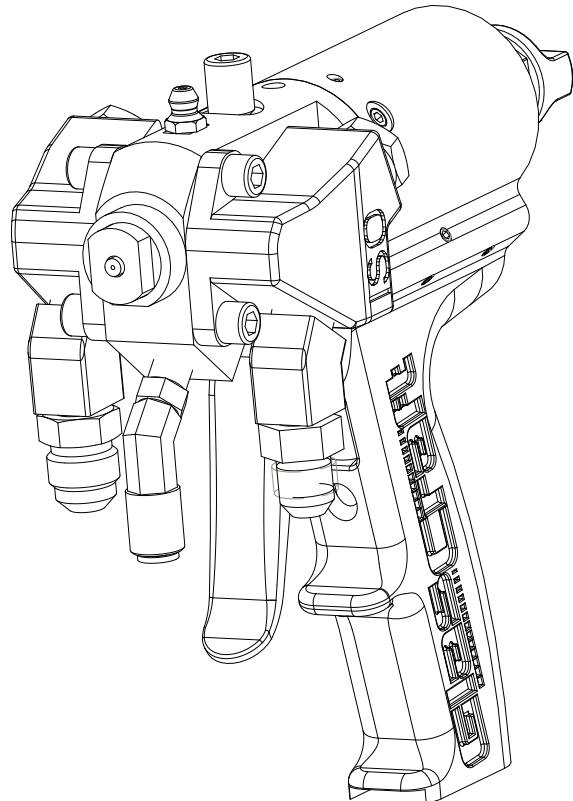

r\_gcp3ra\_313266\_1\_1e



# Table Of Contents

## **Section 1 Installation**

Warnings .....	3
Introduction .....	7
Standard Equipment .....	8
Translations .....	8
Equipment Assembly .....	9

## **Section 2 Operation**

Start-up Instructions .....	11
-----------------------------	----

## **Section 3 General Information**











Assembly Drawings .....	13
Maintenance .....	16
Options .....	21

## **Section 4 Warranty and Reference Information**

Limited Time Warranty .....	25
Technical Assistance .....	26
For Your Reference .....	27

## Warnings

The following warnings are for the setup, use, grounding, maintenance, and repair of this equipment. The exclamation point symbol alerts you to a general warning and the hazard symbol refers to procedure-specific risk. Refer back to these warnings. Additional, product-specific warnings may be found throughout the body of this manual where applicable.

 <b>WARNING</b>	
 	<p><b>TOXIC FLUID OR FUMES HAZARD</b></p> <p>Toxic fluids or fumes can cause serious injury or death if splashed in the eyes or on skin, inhaled, or swallowed.</p> <ul style="list-style-type: none"> <li>• Read MSDS's to know the specific hazards of the fluids you are using.</li> <li>• Store hazardous fluid in approved containers, and dispose of it according to applicable guidelines.</li> <li>• Always wear impervious gloves when spraying or cleaning equipment.</li> </ul>
	<p><b>PERSONAL PROTECTIVE EQUIPMENT</b></p> <p>You must wear appropriate protective equipment when operating, servicing, or when in the operating area of the equipment to help protect you from serious injury, including eye injury, inhalation of toxic fumes, burns, and hearing loss. This equipment includes but is not limited to:</p> <ul style="list-style-type: none"> <li>• Protective eyewear</li> <li>• Clothing and respirator as recommended by the fluid and solvent manufacturer</li> <li>• Gloves</li> <li>• Hearing protection</li> </ul>
  	<p><b>SKIN INJECTION HAZARD</b></p> <p>High-pressure fluid from gun, hose leaks, or ruptured components will pierce skin. This may look like just a cut, but it is a serious injury that can result in amputation. Get immediate surgical treatment.</p> <ul style="list-style-type: none"> <li>• Do not point gun at anyone or at any part of the body.</li> <li>• Do not put your hand over the spray tip.</li> <li>• Do not stop or deflect leaks with your hand, body, glove, or rag.</li> <li>• Close material shutoff valves and then shut off or disconnect air supply when not spraying.</li> <li>• Follow Pressure Relief Procedure in this manual, when you stop spraying and before cleaning, checking, or servicing equipment.</li> </ul>
	<p><b>BURN HAZARD</b></p> <p>Equipment surfaces and fluid that's heated can become very hot during operation. To avoid severe burns, do not touch hot fluid or equipment. Wait until equipment/fluid has cooled completely.</p>
  	<p><b>FIRE AND EXPLOSION HAZARD</b></p> <p>Flammable fumes, such as solvent and paint fumes, in work area can ignite or explode. To help prevent fire and explosion:</p> <ul style="list-style-type: none"> <li>• Use equipment only in well ventilated area.</li> <li>• Eliminate all ignition sources; such as pilot lights, cigarettes, portable electric lamps, and plastic drop cloths (potential static arc).</li> <li>• Keep work area free of debris, including solvent, rags and gasoline.</li> <li>• Do not plug or unplug power cords, or turn power or light switches on or off when flammable fumes are present.</li> <li>• Ground all equipment in the work area.</li> <li>• Use only grounded hoses.</li> <li>• Hold gun firmly to side of grounded pail when triggering into pail.</li> <li>• If there is static sparking or you feel a shock, stop operation immediately. Do not use equipment until you identify and correct the problem.</li> <li>• Keep a working fire extinguisher in the work area.</li> </ul>

## Warnings

### WARNING



#### **EQUIPMENT MISUSE HAZARD**

Misuse can cause death or serious injury.

- Do not operate the unit when fatigued or under the influence of drugs or alcohol.
- Do not exceed the maximum working pressure or temperature rating of the lowest rated system component. See Technical Data in all equipment manuals.
- Use fluids and solvents that are compatible with equipment wetted parts. See Technical Data in all equipment manuals. Read fluid and solvent manufacturer's warnings. For complete information about your material, request MSDS forms from distributor or retailer.
- Check equipment daily. Repair or replace worn or damaged parts immediately with genuine manufacturer's replacement parts only.
- Do not alter or modify equipment.
- Use equipment only for its intended purpose. Call your distributor for information.
- Route hoses and cables away from traffic areas, sharp edges, moving parts, and hot surfaces.
- Do not kink or over bend hoses or use hoses to pull equipment.
- Keep children and animals away from work area.
- Comply with all applicable safety regulations.



#### **PRESSURIZED ALUMINUM PARTS HAZARD**

Do not use 1,1,1-trichloroethane, methylene chloride, other halogenated hydrocarbon solvents or fluids containing such solvents in pressurized aluminum equipment. Such use can cause serious chemical reaction and equipment rupture, and result in death, serious injury, and property damage.

## Warnings

### Isocyanate Hazard



Spraying materials containing isocyanates creates potentially harmful mists, vapors, and atomized particulates.

Read material manufacturer's warnings and material MSDS to know specific hazards and precautions related to isocyanates.

Prevent inhalation of isocyanate mists, vapors, and atomized particulates by providing sufficient ventilation in the work area. If sufficient ventilation is not available, a supplied-air respirator is required for everyone in the work area.

To prevent contact with isocyanates, appropriate personal protective equipment, including chemically impermeable gloves, boots, aprons, and goggles, is also required for everyone in the work area.

To prevent exposing ISO to moisture:

- Always use a sealed container with a desiccant dryer in the vent, or a nitrogen atmosphere. **Never** store ISO in an open container.
- Keep the ISO lube pump reservoir filled with Graco Throat Seal Liquid (TSL), Part 206995. The lubricant creates a barrier between the ISO and the atmosphere.
- Use moisture-proof hoses specifically designed for ISO, such as those supplied with your system.
- Never use reclaimed solvents, which may contain moisture. Always keep solvent containers closed when not in use.
- Never use solvent on one side if it has been contaminated from the other side.
- Always park pumps when you shutdown.
- Always lubricate threaded parts with Part 217374 ISO pump oil or grease when reassembling.

### Moisture Sensitivity of Isocyanates



Isocyanates (ISO) are catalysts used in two component foam and polyurea coatings. ISO will react with moisture (such as humidity) to form small, hard, abrasive crystals, which become suspended in the fluid. Eventually a film will form on the surface and the ISO will begin to gel, increasing in viscosity. If used, this partially cured ISO will reduce performance and the life of all wetted parts.



The amount of film formation and rate of crystallization varies depending on the blend of ISO, the humidity, and the temperature.

## Warnings

### Material Self-ignition

					
Some materials may become self-igniting if applied to thickly. Read material manufacturer's warnings and material MSDS.					

### Keep Components A and B Separate

<b>CAUTION</b>
To prevent cross-contamination of the equipment's wetted parts, never interchange component A (isocyanate) and component B (resin) parts. The gun is shipped with the A side on the left. The fluid manifold, fluid housing, side seal assembly, check valve cartridge, and mix chamber are marked on the A side.

### Foam Resins with 245 fa Blowing Agents

New foam blowing agents will froth at temperatures above 90°F (33 °C) when not under pressure, especially if agitated. To reduce frothing, minimize preheating in a circulation system.

### Changing Materials

- When changing materials, flush the equipment multiple times to ensure it is thoroughly clean.
- Always clean the fluid inlet strainers after flushing.
- Check with your material manufacturer for chemical compatibility.
- Most materials use ISO on the A side, but some use ISO on the B side.
- Epoxies often have amines on the B (hardener) side. Polyureas often have amines on the B (resin) side.

## Section 1 - Installation: Introduction

### Introduction

Before operating, maintaining or servicing any **GlasCraft** system, read and understand all of the technical and safety literature provided with **GlasCraft** products. If you do not have the proper or related manuals and safety literature for your **GlasCraft** system, contact your **GlasCraft** distributor.

In this **GlasCraft** technical and safety publication, the following advisories will be provided where appropriate:



*Information about the procedure in progress.*



Indicates a hazardous situation that can result in death or serious injury.

The information in this document is intended only to indicate the components and their normal working relationship typical use. Each assembly should be directed by a **GlasCraft** distributor or made from the **GlasCraft** Assembly instructions provided.

This manual provides information for the assembly, operation, maintenance and service of this **GlasCraft** product as used in a typical configuration. While it lists standard specifications and procedures, some deviations may be found.

In order to provide our users with the most up-to-date technology possible, we are constantly seeking to improve products. If a technological change occurs after a product is on the market, we will implement that technology in future production and, if practical, make it available to current users as a retrofit, update or supplement. If you find a discrepancy between your unit and the available documentation, contact your **GlasCraft** distributor to resolve the difference.

Careful study and continued use of this manual will provide a better understanding of the equipment and process, resulting in more efficient operation, longer trouble-free service and faster, easier troubleshooting.

## Section 1 - Installation: Standard Equipment

<b>Standard Equipment</b>	
<b>Part Number</b>	<b>Description</b>
GCP2RX	Probler P2 Dispense Gun
313266	User Manual

<b>Translations</b>	
<b>Manual No.</b>	<b>Langauge</b>
3A0474	Spanish
3A0475	French



## Section 1 - Installation: Equipment Assembly

### How The Gun Works

The trigger actuates a small valve in the gun handle that controls the flow of air into the piston assembly. When the trigger is pulled, air flows through the valve to the front of the piston. Air pressure forces the piston towards the rear of the gun, simultaneously closing off the purge air and moving the mixing chamber to a position where the mixing chamber orifices are aligned with the orifices in both, the side block seal and check valve assemblies.



The proper alignment of the orifices is determined by the setting of the adjustment nut, located on the piston lock assembly. This adjustment nut determines the length of travel of the air piston and has been preset at the factory and should not require adjustment. (SEE MAINTENANCE SECTION)

The two fluids (isocyanate and polyol) then flow through the material shut-off valves, seal, and check valve assemblies and into the mixing chamber. The two fluids impinge against one another and exit the mixing chamber in a swirling, conical spray pattern.

When the trigger is released, the mixing chamber returns to its original position and purge air flows into the mixing chamber housing. The front tip o-ring keeps air purge inside the gun head, which forces all of the air through the orifices in the mixing chamber creating a complete, total and constant purge.

This purge air continues to flow through the mixing chamber until the air valve has shut-off all air to the gun; or until the trigger is pulled again.

### Piston Lock

Engage piston lock whenever you stop spraying, to avoid accidental triggering.

Always use piston lock in conjunction with fluid ball valves to avoid accidental triggering.



Read warnings, page 3.

**To engage Piston lock:** push knob in and turn clockwise. If engaged, gun will not actuate.

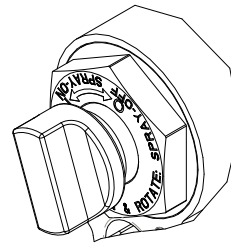

r\_257826\_313266\_1\_2b

**To disengage piston lock:** push knob in and turn counterclockwise until it pops out. There will be a gap between knob and gun body.

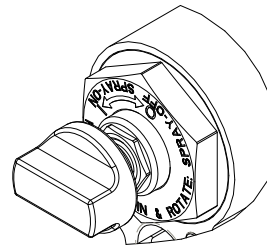

r\_257826\_313266\_1\_1b

See page 19 for piston lock adjustment or installation.

### Loss of Air Pressure

In event of loss of air pressure, gun will continue to spray. To shut off gun, do one of the following:

- Push in piston lock, see **Engage piston lock**.
- Close ball valves A and B.

## Section 1 - Installation: Equipment Assembly

### GlasCraft Equipment

Air Hose is 1/4" in. NPS

JIC and SAE Fittings **DO NOT** require the use of PTFE tape.

Once the fittings are attached and tight, refer to system manuals for start-up instructions.

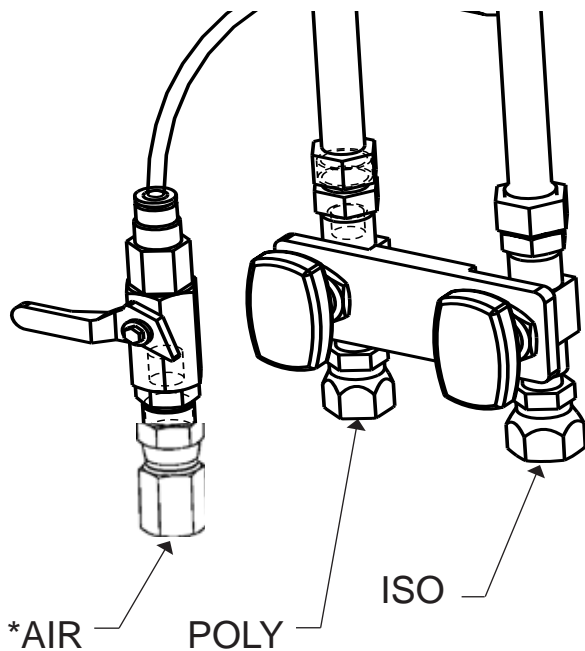

 The P2 Elite gun attaches the same way if equipped with the optional horizontal set-up.

\* Fitting GC2394 is an unattached part that may need to be connected to the air hose first, and then connected to the gun depending on the air hose fitting.

### Installing P2 Elite on Other Equipment

#### WARNING

*Do not place any part of the body in the path of the material spray.*

*Do not point the gun at or near other personnel.*

*Do not look into the mixing chamber orifice at any time.*

*Because of the hazardous materials used in this equipment, it is recommended that the operator use an air mask, goggles, protective clothing, and other safety equipment as prescribed by current regulations, recommendations of the chemical suppliers, and the laws in the area where the equipment is being used.*

If original equipment does not require the use of an unheated whip hose or isolation hose, the P2 can be directly installed on to the material hose.

1. Remove the fittings from the original gun.
2. Remove swivel fittings from ball valves. Ball valves are 1/8 in. NPT female. Remove swivel fitting from air slide valve. The air slide valve is a 1/4 in. NPSM.

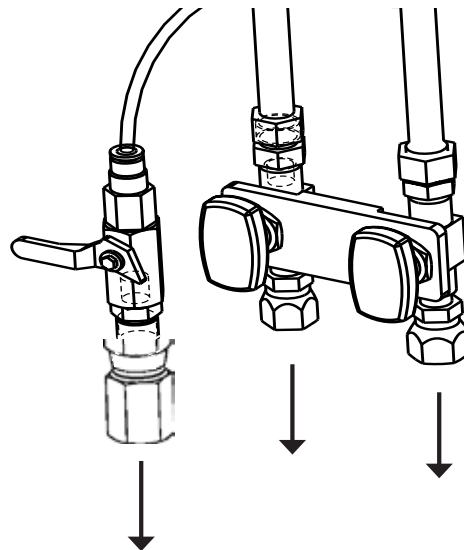

3. Install the original fittings into ball valves.

 It is recommended to use a non-permanent thread lock on the 1/8 in. NPT threads to assist as a sealant and keep the fittings from twisting with gun movement.

4. Install the gun on the original Hoses.

#### WARNING

*Relieve ALL system fluid and air pressures according to manufacturer's instructions.*

## Section 2 - Operation: Start-Up Instructions



Refer to specific system user manuals for complete system installation.

### Pre operation Checklist

Check that all fittings are tight and air regulators are turned to “zero pressure”.

#### WARNING

Do not place any part of the body in the path of the material spray.

Do not point the gun at or near other personnel.

Do not look into the mixing chamber orifice at any time.

Because of the hazardous materials used in this equipment, it is recommended that the operator use an air mask, goggles, protective clothing, and other safety equipment as prescribed by current regulations, recommendations of the chemical suppliers, and the laws in the area where the equipment is being used.

### Operating Requirements

- 8 - 10 CFM at 90 -110 psi (0.62-0.76 MPa, 6.2-7.6 bar)
- MAXIMUM Static Fluid Pressure - 3200 psi (22 MPa, 220 bar)

#### WARNING

The GlasCraft Probler P2 Elite Gun is designed and manufactured to operate at a maximum static fluid pressure not to exceed 3200 psi (22 MPa, 220 bar). When attached to a GlasCraft proportioning system, this pressure will not be exceeded. However, if the GlasCraft Probler P2 Elite gun is installed on any other manufacturer's self-designed equipment, great care must be taken to ensure that the maximum static fluid pressure not be exceeded.



If the gun is being used for short periods of spraying, GlasCraft recommends that the purge air be left ON.

#### WARNING

If purge air is to be turned OFF, BOTH MATERIAL SHUT-OFF VALVES MUST BE TURNED TO THEIR “OFF” POSITION BEFORE TURNING “OFF” THE PURGE AIR !

Failure to follow this procedure will possibly result in the gun head becoming encased with mixed product.

For proper purging following use, the air switch must be left OPEN for at least 15 SECONDS after the trigger has been released.

The flow of material into the mixing chamber is controlled by the ON or OFF position of the two material shut-off valves.



Both material shut-off valves must be FULLY OPEN and piston lock DISENGAGED during dispensing and must be FULLY CLOSED and piston lock ENGAGED during service or extended shut-down periods.

#### WARNING

BOTH MATERIAL SHUT-OFF VALVES MUST BE TURNED TO THEIR “OFF” POSITION AND ALL FLUID PRESSURE RELIEVED BEFORE REMOVING SIDE-BLOCK SCREWS!

Failure to follow this procedure will possibly result in the gun head becoming encased with mixed product.

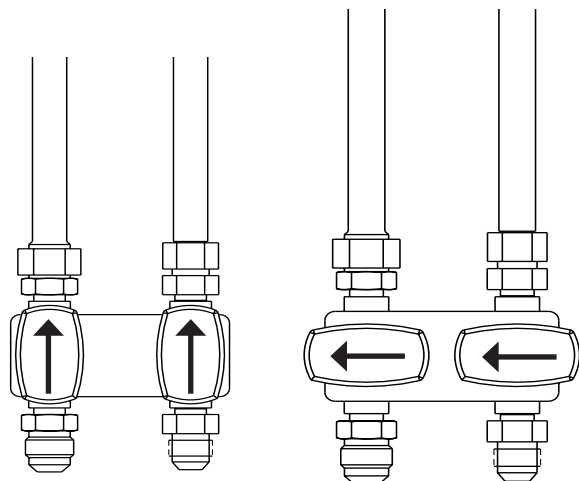

ON

OFF

Refer to system manuals for start-up and shut-down procedures.

## Section 2 - Operation: Start-Up Instructions

### Spray Technique

Always operate safely and follow all safety procedures outlined.

To achieve the optimum spray pattern for each application, the appropriate mixing chambers are available in seven sizes.

The standard mixing chamber supplied with your gun will be adequate for all but the smallest and largest applications.

Foam rise and cure times will vary according to the material and substrate temperature. Higher material or substrate temperature will increase rise and cure times; lower material or substrate temperatures will decrease rise and cure times. Consult your chemical manufacturer's data specification sheets for their recommended spray temperatures. Under most circumstances, both components will be used at identical temperatures.

Higher pressures and temperatures may be used to increase material break-up, improve mixing and speed rise times. With hose lengths over 50 ft. (15.25 m), or when material viscosities are high, higher material pump pressures may be necessary.

The gun air valve **MUST BE OPENED** prior to spraying to provide air for trigger operation and purge air when the trigger is released.

When spraying, the gun trigger may be depressed continuously, or triggered at the end of each stroke. A smooth, even layer is best achieved by moving the gun back and forth in a slow, even motion, overlapping the previous pass about 50 to 75 percent. **DO NOT SPRAY OVER RISING FOAM!** The ideal gun-to-surface distance is about 18 to 24 inches. Be sure to point the gun directly at the surface to be sprayed. Spraying at an angle to the surface will cause the foam to be rough and will generate overspray.

# Section 3 - General Information: P2 Elite Dispense Gun

Part	A	B	Kit
GCP3RA	GC250A	GC251A	GC1948
GCP3R0	GC2500	GC2510	GC1947
GCP3R1	GC2501	GC2511	GC1947
GCP3R2	GC2502	GC2512	GC1947
GCP3R3	GC2503	GC2513	GC1947
GCP3R4	GC2504	GC2514	GC1949
GCP3R5	GC2505	GC2515	GC1949

1. Apply permanent thread locker and torque to 35-40 in.-lbs (4-4.5 N•m).
2. Apply liberal coating of lubricant to seals and surfaces specified.
3. Adjust counter-clockwise until it bottoms out.

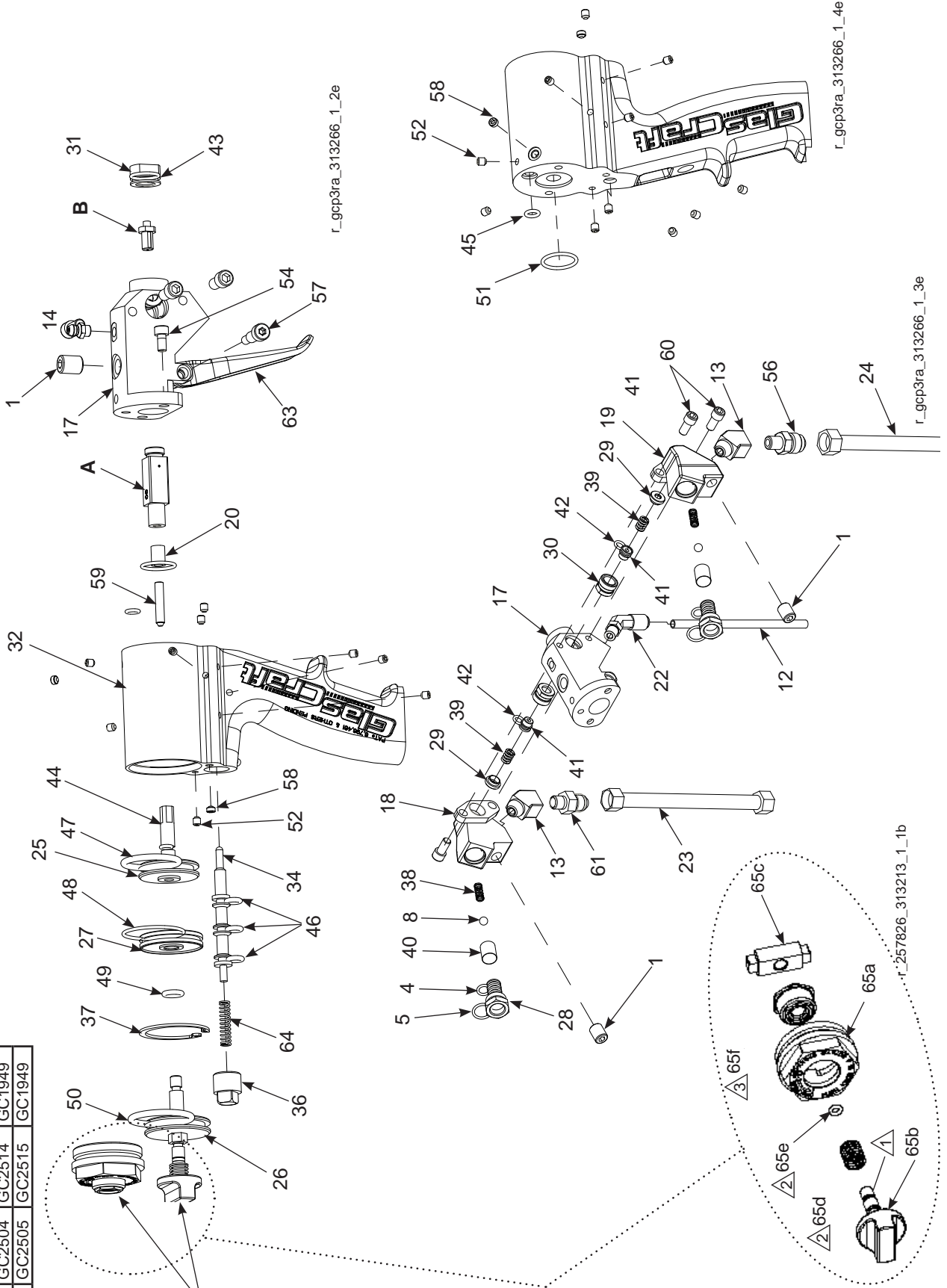

# Section 3 - General Information: P2 Elite Dispense Gun

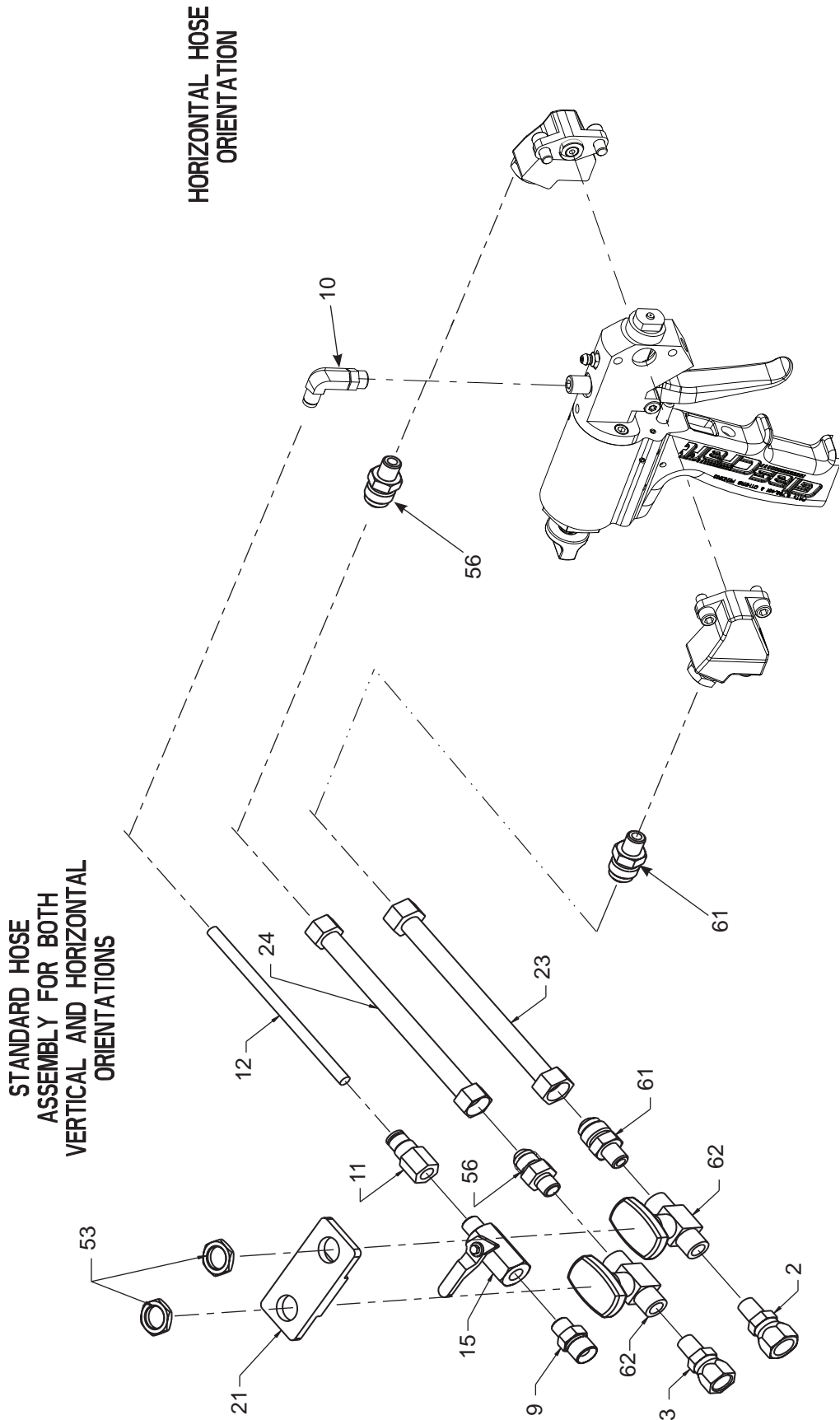

r\_gcp3ra\_313266\_1\_5e

## Section 3 - General Information: P2 Elite Parts List

Ref.	Part	Description	Qty.
1	GC0024	PIPE PLUG	3
2	117634	SWIVEL HOSE FITTING	1
3	117635	SWIVEL HOSE FITTING	1
4	GC0043	O-RING	2
5	GC0044	O-RING	2
7 ☆		HEATED HOSE COVER	2
8	GC0259	1/4 IN. DIA. BALL	2
9	GC0275	FITTING	1
10	GC0490	ELBOW FITTING	1
11	GC0502	FITTING	1
12 ☆		TUBING, 1000 PSI; NYLON	3
13	GC0712	ELBOW FITTING	2
14	GC1198	LUBE FITTING	1
15	GC1842	BALL VALVE	1
16 ❖	GC2394	SWIVEL FITTING	1
17	GC1880	P2-ELITE HEAD	1
18	GC1881	P2 ELITE POLY SIDE BLOCK	1
19	GC1882	P2 ELITE ISO SIDE BLOCK	1
20	GC1883	PISTON SPACER	1
21	GC1884	HOSE MOUNTING PLATE	1
22	GC1885	PUSHLOCK SWIVEL ADAPTER	1
23	GC1886	WHIP HOSE	1
24	GC1887	WHIP HOSE	1
25	GC1898	AIR PISTON	1
26	GC1899	AIR PISTON	1
27	GC1900	CYLINDER SPACER	1
28	GC1904	CHECK VALVE FILTER	2
29	GC2494	SEAL, ACETAL	2
30	GC2495	SEAL HOUSING	2
31	GC1914	AIR CAP	1
32	GC2499	MACHINED HANDLE	1
34	GC1918	TRIGGER PISTON	1
36	GC1920	TRIGGER PLUG	1
37	GC1921	RETAINING RING	1
38	GC1922	SPRING	2
39	GC1923	SPRING	2
40	GC2496	FILTER SCREEN; 40 MESH 100 MESH FILTER (GC2497) ALSO AVAILABLE	2
41	GC2498	SIDE SEAL	2
42	111450	O-RING	2

Ref.	Part	Description	Qty.
43	117517	O-RING	1
44	C20988	O-RING	1
45	GC2056	O-RING	1
46	GC2058	O-RING	3
47	108833	O-RING	1
48	107563	O-RING	1
49	GC2059	O-RING	1
50	C20207	O-RING	1
51	GC2060	O-RING	1
52	GC2081	SET SCREW	11
53 ☆		HEX NUT; 9/16-27	2
54	GC2187	SCREW	2
56	GC2212	FITTING	2
57	GC2237	SHOULDER SCREW	1
58	GC2241	SET SCREW	2
59	GC2244	SET SCREW	1
60	GC2248	SCREW	4
61	GC2334	FITTING	2
62	GC2337	BALL VALVE	2
63	GC2340	TRIGGER	1
64	GC2341	SPRING	1
65	258761	PISTON LOCK ASSEMBLY	1

Ref. No.	Part No.	Description	Qty.
65a		AIR CAP	1
65b ❖		STOP SHAFT	2
65c ❖		PISTON STOP	1
65d ❖		COMPRESSION SPRING	1
65e ❖		O-RING	1
65f		ADJUSTMENT NUT	1

❖ Included with kit 258762.

☆ Purchase locally.

❖ Not Shown.

## Section 3 - General Information: Maintenance

### WARNING

Before attempting to perform any maintenance on this gun, relieve All Fluid and Air Pressures!

- To relieve fluid and air pressures:
- Turn OFF all air supplies at system except gun trigger air.
- Trigger the gun until all fluid pressures have been relieved.
- Turn OFF the gun trigger air at the system.
- Turn proportioner off.
- Trigger the gun until all trigger air pressure has been relieved.

Perform Gun maintenance as follows:

#### 1. Check for leaking seals (41).

- Engage piston lock.
- Turn OFF the gun incoming air by closing gun air valve.
- Turn ON the material ball valves.

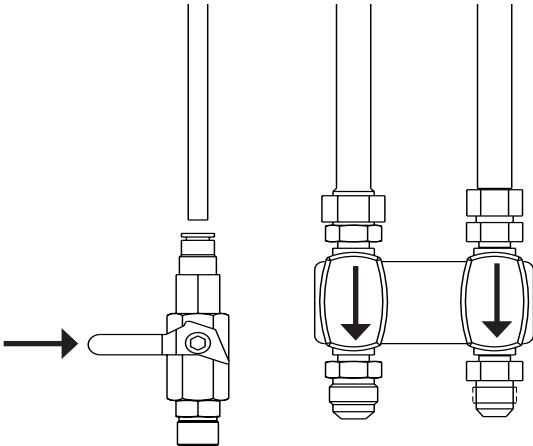

- Wait approximately 10 - 20 seconds, then turn ON the incoming air by opening gun air valve.
- Repeat two or three times.
- If any material has been purged from the gun, the seals (41) or o-ring (42) are leaking.
- Correct leaks by replacing the seals or o-rings and re-checking.

#### 2. Check the material valves, p/n GC2337 for any leaks:

- Turn OFF both material valves.

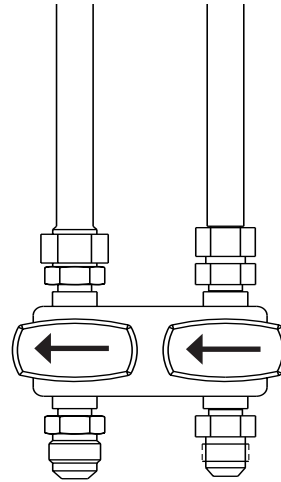

- Disengage piston lock.
- Trigger the gun several times.
- Wait approximately 10-20 seconds.
- Trigger the gun several times.
- If additional material is purged, the material valves are leaking.
- Correct the leaks by taking off black knobs and turning packing 1/8 in. to 1/4 in. turns at a time until the leak has stopped. Re-check.

#### 3. Check side blocks

- Turn OFF the air valve.

### WARNING

Before removing the side blocks make certain that both material valves are in the OFF position. Then trigger the gun several times to relieve pressure.

If the material valves are on when the side blocks are removed the gun will quickly become encased in urethane!

### WARNING

Point gun side blocks down, away from all personnel. Existing fluid pressures could cause material to exit the side blocks with considerable force.



## Section 3 - General Information: Maintenance

- Take the side blocks off by removing screws.

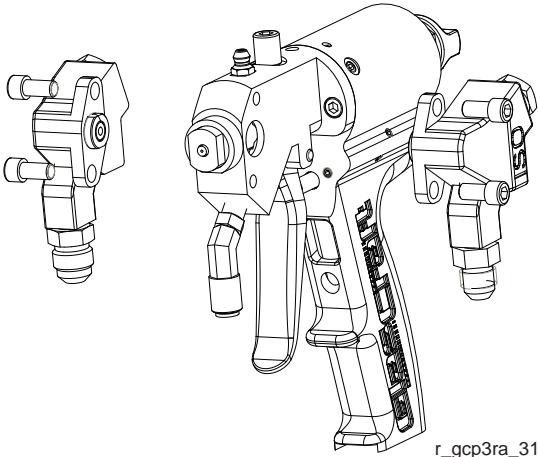

- Use correct size drill bit to clean out the mixing chamber exit passage. Use correct size drill bit to clean the inlet side holes of the mixing chamber taking care not to scratch the mixing chamber's polished surfaces. (Refer to the drill chart in this manual.)

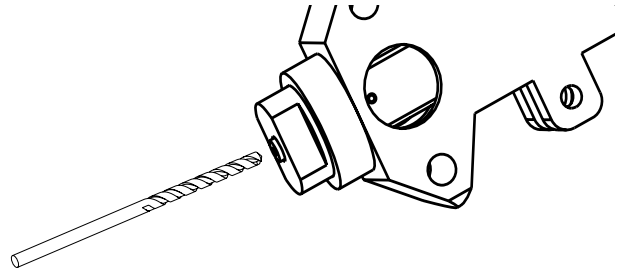

- Examine the sides of the mixing chamber for scratches and/or material build-up. Carefully, without scratching the seal surfaces (sides), remove any accumulated material. Solvent can be used to wash accumulated material off of chamber, side blocks, etc. Keep the gun chamber tilted toward the ground so that solvent does not run back into gun. Certain solvents will attack o-rings on chamber shaft causing swelling and deterioration of o-rings.

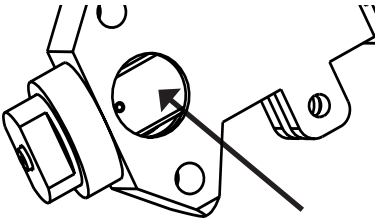

- Re-assemble the side blocks and tighten the screws. Grease should appear at the tip of the mixing chamber.

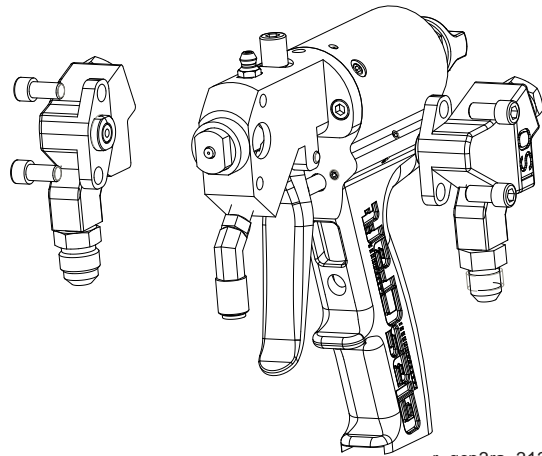

- Place generous amounts of high quality, white lithium grease in each side of the gun front housing and on the side block seals.

 **DO NOT** open the air valve because this will purge grease from the Gun. The grease should be allowed to remain in the gun overnight.

## Section 3 - General Information: Maintenance

### Daily Shutdown

*For experienced users*

Once you have used the gun with a product and system, and you have become comfortable with techniques on how all the variables are affecting your operations and maintenance requirements, Daily, Weekly, and Monthly Maintenance requirements can be addressed specific to your operation.

1. Turn the ball valves off, p/n GC2337, and trigger the gun 5 - 6 times to purge residual pressure.

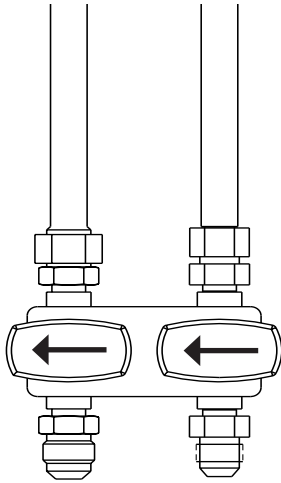

2. Engage piston lock.
3. Drill out the chamber insert snout with correct size drill bit for insert. (Refer to the drill chart in this manual.)
4. Turn valve halfway back to limit the air purge.

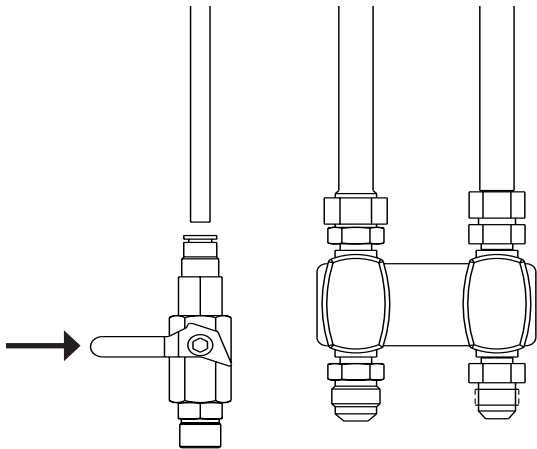

5. Inject white lithium grease into zerk fitting until a light mist of grease is purged through the snout. Shut off the air purge.

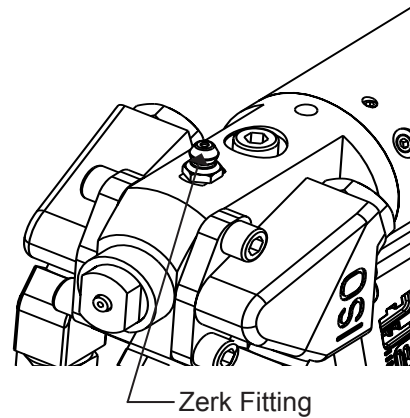

6. Remove the air cap and set to side. If solvent soaking is required, remove the o-ring, before soaking.
7. Remove the snout insert and soak in solvent until next usage.

### Daily Start-up

1. Clean the snout insert. Be sure both the face and bottom flat are clean. Drill the snout bore out with the correct size bit for snout. (Refer to the drill chart in this manual.)
2. Clean the inner bore of the chamber. Drill out the chamber snout inlet bore as required.
3. Install the snout insert.
4. Install the air cap on to the chamber. Tighten finger tight until the cap bottoms out. Snug down with a 1/2 in. wrench. This does not require high torque. Over tightening can result in chamber damage.

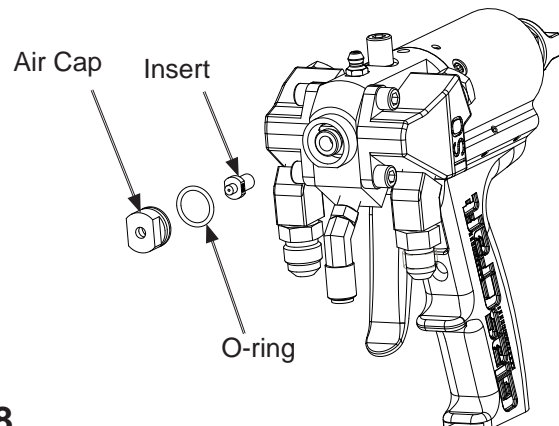

## Section 3 - General Information: Maintenance



Refer to specific system user manuals for complete system installation.

### Parts Replacement Procedure

#### WARNING

*Before attempting to perform any maintenance on this gun OR before removing the side blocks, make certain that both gun material valves are in the OFF positions and trigger several times to depressurize fluid in gun!*

*If the material valves are on when side blocks are removed, the gun will quickly become encased in urethane!*

1. Read each procedure entirely before beginning and refer to the illustrations as needed.
2. Flush and clean all chambers and passages as they become accessible.
3. Clean all parts before assembly.
4. Replace all o-rings and seals with new parts from the appropriate kit.
5. Inspect all parts for wear or damage and replace as required with new *genuine GlasCraft replacement parts from your authorized GlasCraft distributor.*
6. Inspect all threads for wear or damage and replace as required.
7. Tighten all threaded parts securely, but not excessively, upon assembly.
8. Lightly lubricate all o-rings and threads with lithium grease.
9. Check all springs for resilience. They should return quickly to their original (new) length.

### Routine Care

#### WARNING

*Before attempting to perform any maintenance on this gun OR before removing side blocks, make certain that both gun material valves are in the fully OFF positions and trigger several times to depressurize fluid in gun!*

*If the material valves are on when side blocks are removed, the gun will quickly become encased in urethane!*

*It is recommended that the following service be performed on a daily basis.*

1. Clean the gun using a brush and an appropriate clean solvent.
2. Inspect the side block seals making certain they are clean and free of scratches, nicks or foreign material. Clean and replace as required.
3. Remove, clean or replace the filter screen.
4. Maintain a reasonable stock level of “wear” items such as seals and o-rings. (see Service & Repair Parts Kits listed in Parts & Illustrations section.)

## Section 3 - General Information: Maintenance

### Piston Lock Adjustment and Installation Procedure

The P2 gun piston throw is factory set and as a rule, should not require adjustment. The piston throw refers to how far back the air piston will travel when the gun is triggered. Proper throw adjustment will align the mixing chamber side ports with the side block seal thru port. There is a set screw that determines how far the piston will travel before it stops.

To determine if the throw is correct:

1. Follow the **pressure relief procedure** on page 16 and disconnect material hoses from the gun.
2. Turn the material ball valves to the OFF position.

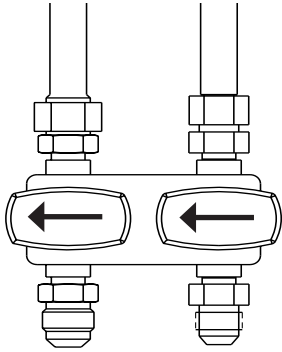

3. Verify that the piston lock cap has been tightened and fully threaded into the gun.
4. Remove the side blocks.

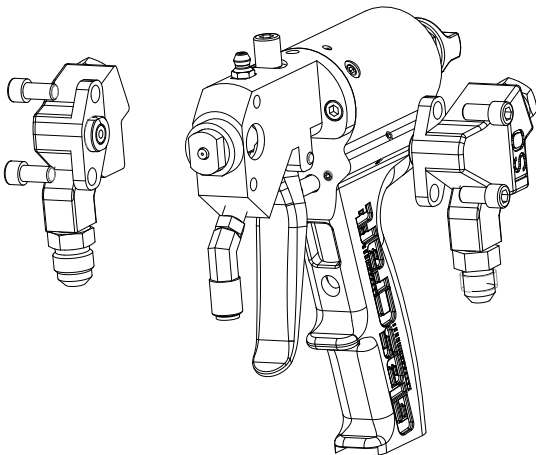

r\_gcp3ra\_313266\_1\_6e

5. Remove one of the side block seal housings, from side block. Leave the seal (34) in housing and rinse with suitable solvent.

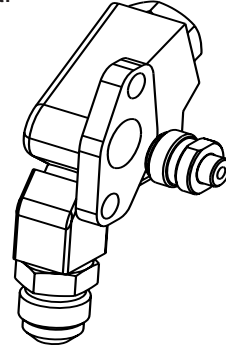

6. Place the side seal housing in the gun head so the face of the seal sets against the mix chamber.

#### WARNING

*If the material valves are on when side blocks are removed, the gun will quickly become encased in urethane!*

7. Turn the gun trigger air supply on, then trigger the gun.



*The purge air will not shut off with the side block removed.*

8. If the impingement port is not fully visible through the side seal housing turn the trigger-air off and trigger the gun to relieve pressure. Use a 9/16 in. open-end wrench to adjust the adjustment nut in the appropriate direction. Repeat steps 7 and 8 until it is adjusted properly.

9. If the impingement port on the mix chamber is fully visible through the side seal housing (either on center or slightly forward), the piston lock adjustment nut is properly aligned.



*Non-permanent thread locker can be applied to the adjustment nut if necessary.*

10. Reassemble the gun.

**Before each use:** Verify that the piston lock assembly is installed and working properly.

- Engage piston lock.
- Pressurize the system to working pressure.
- Open material ball valves.
- Point the gun in a safe direction and trigger gun. No material should flow from gun tip.
- **DO NOT USE IF IT IS NOT WORKING PROPERLY.**

## Section 3 - General Information: Options

### Service & Repair Kits

GC1937 Standard Repair Kit		
Part	Description	Qty.
C20988	O-Ring	1
GC2056	O-Ring	1
110242	O-Ring	2
106555	O-Ring	2
GC2057	O-Ring	1
GC2058	O-Ring	3
108833	O-Ring	1
107563	O-Ring	1
GC2059	O-Ring	1
C20207	O-Ring	1
GC2060	O-Ring	1
GC0043	O-Ring	2
GC044	O-Ring	2
111450	O-Ring	2
117517	O-Ring	1

 O-ring p/n's GC2057 and 110242 (QTY. 1) are not used on the P2 Elite gun.

GC1949 Hardware Kit 04-05		
Part	Description	Qty.
GC0086	3/16" Ball Driver	1
GC0087	5/32" Ball Driver	1
GC0175	Pin Vise	1
GC2496	Screen Filter	2
GC0075	Drill Bit	1
GC0076	Drill Bit	1
117517	O-Ring	1
111450	O-Ring	2
GC2212	37 Deg. Connector Fitting	1
GC2334	45 Deg. Connector Fitting	1
GC2394	Adapter Fitting	1

GC194 Hardware Kit -AA		
Part	Description	Qty.
GC0082	Drill Bit	1
GC0081	Drill Bit	1
GC0086	3/16" Ball Driver	1
GC0087	5/32" Ball Driver	1
GC0175	Vise Pin	1
GC1924	Filter Screen	2
111450	O-Ring	2
117517	O-Ring	1

GC1947 Hardware Kit 00-03		
Part	Description	Qty.
GC0086	3/16" Ball Driver	1
GC0087	5/32" Ball Driver	1
GC0175	Pin Vise	1
GC2496	Screen Filter	2
GC0068	Drill Bit	1
GC0069	Drill Bit	1
GC0070	Drill Bit	1
GC0072	Drill Bit	1
GC0073	Drill Bit	1
GC0074	Drill Bit	2
GC0077	Drill Bit	1
GC0083	Drill Bit	1
GC2212	37 Deg. Connector Fitting	1
GC2334	45 Deg. Connector Fitting	1
117517	O-Ring	1
111450	O-Ring	2
GC2394	Adapter Fitting	1

GC1946 Side Seal Kit		
Part	Description	Qty.
GC2498	SST Side Seal	2
111450	O-Ring	2

GC1950 Premium Repair Kit		
Part	Description	Qty.
GC1931	O-Ring	1
111516	O-Ring	1
111450	O-Ring	4
113137	O-Ring	2
111316	O-Ring	2
118594	O-Ring	1
117724	O-Ring	2
117517	O-Ring	1
GC1932	O-Ring	3
GC1933	O-Ring	1
GC1934	O-Ring	1
GC1935	O-Ring	1
GC1936	O-Ring	1
117610	O-Ring	1

258762, Piston Lock Repair Kit		
Part	Description	Qty.
	Stop Shaft	1
	Piston Stop	1
	Compression Spring	1
	O-Ring	1

## Section 3 - General Information: Options

### Cleaning Drill Chart

Round Mixing Chamber	Mixing Chamber Nozzle Cleaning Drill		Mixing Chamber Hole Cleaning Drill	
GC250A	GC0081	0.033	GC0082	0.022
GC2500	GC0083	0.049	GC080	0.035
GC2501	GC0068	0.057	GC0073	0.042
GC2502	GC0069	0.071	GC0074	0.052
GC2503	GC0072	0.086	GC0070	0.059
GC2504	GC0075	0.094	GC0071	0.067
GC2505	GC0076	0.116	GC0072	0.086
DRILL PIN VISE GC0175				

Tungsten Carbide Tip		
Part No.	Orifice Diameter	Spray Width (degrees)
GC2573	0.015 in.	25
GC2574	0.015 in.	40
GC2575	0.018 in.	25
GC2576	0.018 in.	40
GC2577	0.018 in.	50
GC2578	0.021 in.	25
GC2579	0.021 in.	40
GC2580	0.021 in.	50
GC2581	0.021 in.	65
GC2582	0.023 in.	25
GC2583	0.023 in.	40
GC2584	0.023 in.	50
GC2585	0.023 in.	60
GC2586	0.026 in.	40
GC2587	0.026 in.	50
GC2589	0.031 in.	25
GC2590	0.031 in.	40
GC2591	0.031 in.	50
GC2592	0.036 in.	25

Tungsten Carbide Tip		
Part No.	Orifice Diameter	Spray Width (degrees)
GC2593	0.036 in.	40
GC2594	0.036 in.	50
GC2595	0.038 in.	40
GC2596	0.038 in.	50
GC2597	0.043 in.	50
GC2598	0.043 in.	65
GC2599	0.052 in.	25
GC2600	0.052 in.	40
GC2601	0.052 in.	65
GC2602	0.052 in.	25
GC2603	0.062 in.	25
GC2604	0.062 in.	40
GC2605	0.062 in.	50
GC2606	0.062 in.	65
GC2607	0.072 in.	40
GC2608	0.072 in.	50
GC2609	0.078 in.	40

## Section 3 - General Information: Options

### P2 Elite Spray Options

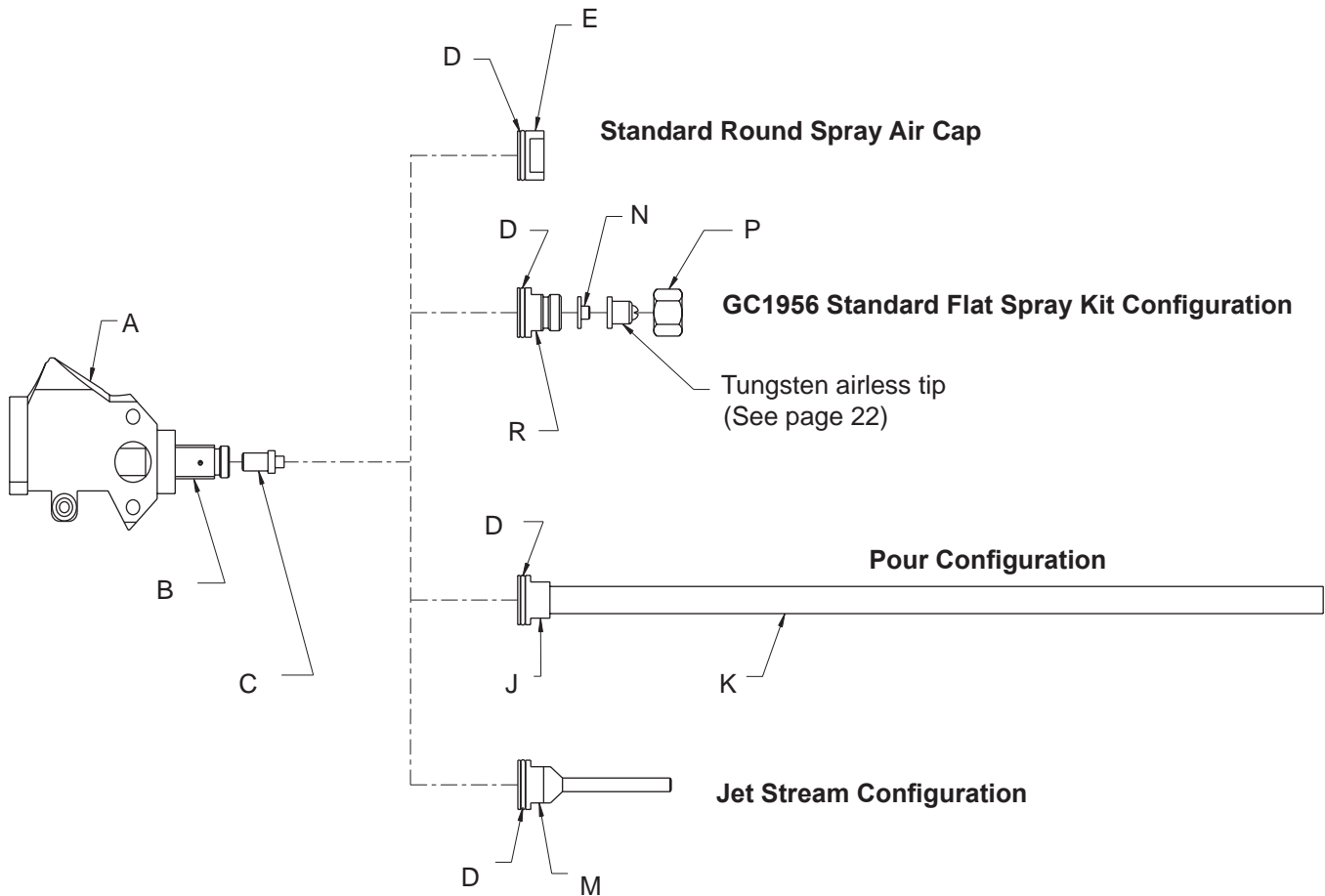

<b>P2 Elite Spray Options</b>		
Ref.	Part	Description
A	GC1880	Gun Head
B	GC250X	Mix Chamber Body
C	GC251X	Mix Chamber Insert
D	117517	Oring
E	GC1914	Front Tip
J	GC1954	Pour Cap
K ☆		Tubing, 1/4 in. ID
M	GC1952 GC1953	Jet Nozzle
N	GC2335	Seal
P	GC0257	Retaining Nut
R	GC1926	Flat Spray Adapter

☆ Purchase locally.

## Section 3 - General Information: Options

### Static Mixer Kit GC1956

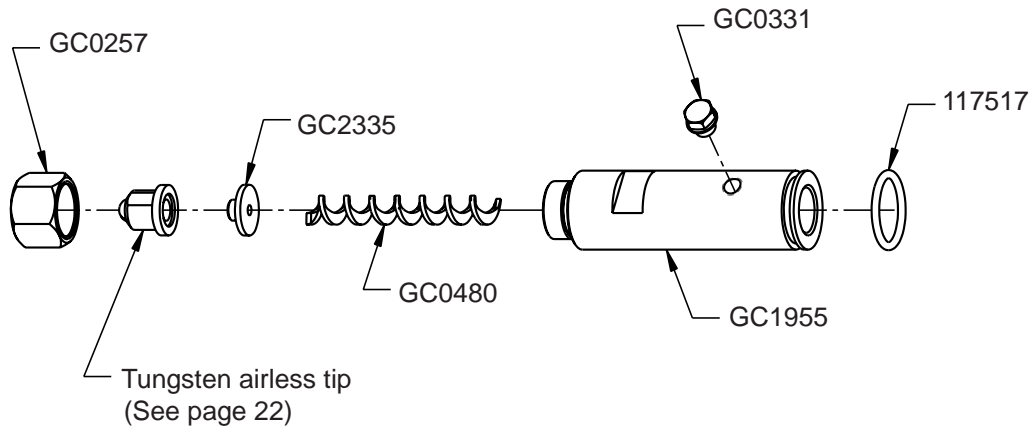

<b>GC1956, Static Mixer Kit</b>		
<b>Part Number</b>	<b>Description</b>	<b>Qty.</b>
GC2335	Fluid Nozzle Seal	1
GC0257	Nozzle Nut	1
GC0331	Plug Fitting	1
GC0480	Spiral Mixing Element	1
117517	O-Ring	1
GC1955	Static Mixer Adapter	1



## Section 4 - Limited Warranty Policy

### Graco Standard Warranty

Graco warrants all equipment referenced in this document which is manufactured by Graco and bearing its name to be free from defects in material and workmanship on the date of sale to the original purchaser for use. With the exception of any special, extended, or limited warranty published by Graco, Graco will, for a period of twelve months from the date of sale, repair or replace any part of the equipment determined by Graco to be defective. This warranty applies only when the equipment is installed, operated and maintained in accordance with Graco's written recommendations.

This warranty does not cover, and Graco shall not be liable for general wear and tear, or any malfunction, damage or wear caused by faulty installation, misapplication, abrasion, corrosion, inadequate or improper maintenance, negligence, accident, tampering, or substitution of non-Graco component parts. Nor shall Graco be liable for malfunction, damage or wear caused by the incompatibility of Graco equipment with structures, accessories, equipment or materials not supplied by Graco, or the improper design, manufacture, installation, operation or maintenance of structures, accessories, equipment or materials not supplied by Graco.

This warranty is conditioned upon the prepaid return of the equipment claimed to be defective to an authorized Graco distributor for verification of the claimed defect. If the claimed defect is verified, Graco will repair or replace free of charge any defective parts. The equipment will be returned to the original purchaser transportation prepaid. If inspection of the equipment does not disclose any defect in material or workmanship, repairs will be made at a reasonable charge, which charges may include the costs of parts, labor, and transportation.

**THIS WARRANTY IS EXCLUSIVE, AND IS IN LIEU OF ANY OTHER WARRANTIES, EXPRESS OR IMPLIED, INCLUDING BUT NOT LIMITED TO WARRANTY OF MERCHANTABILITY OR WARRANTY OF FITNESS FOR A PARTICULAR PURPOSE.**

Graco's sole obligation and buyer's sole remedy for any breach of warranty shall be as set forth above. The buyer agrees that no other remedy (including, but not limited to, incidental or consequential damages for lost profits, lost sales, injury to person or property, or any other incidental or consequential loss) shall be available. Any action for breach of warranty must be brought within two (2) years of the date of sale.

**GRACO MAKES NO WARRANTY, AND DISCLAIMS ALL IMPLIED WARRANTIES OF MERCHANTABILITY AND FITNESS FOR A PARTICULAR PURPOSE, IN CONNECTION WITH ACCESSORIES, EQUIPMENT, MATERIALS OR COMPONENTS SOLD BUT NOT MANUFACTURED BY GRACO.** These items sold, but not manufactured by Graco (such as electric motors, switches, hose, etc.), are subject to the warranty, if any, of their manufacturer. Graco will provide purchaser with reasonable assistance in making any claim for breach of these warranties.

In no event will Graco be liable for indirect, incidental, special or consequential damages resulting from Graco supplying equipment hereunder, or the furnishing, performance, or use of any products or other goods sold hereto, whether due to a breach of contract, breach of warranty, the negligence of Graco, or otherwise.

### FOR GRACO CANADA CUSTOMERS

The Parties acknowledge that they have required that the present document, as well as all documents, notices and legal proceedings entered into, given or instituted pursuant hereto or relating directly or indirectly hereto, be drawn up in English. Les parties reconnaissent avoir convenu que la rédaction du présente document sera en Anglais, ainsi que tous documents, avis et procédures judiciaires exécutés, donnés ou intentés, à la suite de ou en rapport, directement ou indirectement, avec les procédures concernées.

### Graco Information

For the latest information about Graco products, visit [www.graco.com](http://www.graco.com).

TO PLACE AN ORDER, contact your Graco distributor or call to identify the nearest distributor.  
Phone: 612-623-6921 or Toll Free: 1-800-328-0211 Fax: 612-378-3505

## Section 4 - Technical Assistance

### ***Thank You for selecting GlasCraft spray equipment***

*Should you have any questions or need technical assistance, contact your factory authorized GlasCraft distributor.*

*Distributor:* \_\_\_\_\_

*Phone:* \_\_\_\_\_

*Contact:* \_\_\_\_\_

For any issues your distributor cannot address, the GlasCraft technical service department is always available to assist you with the operation of your spray equipment. To help our technical representatives expedite your call and better address your questions, please have the following information ready and available when you phone GlasCraft.

**\* If your questions are not urgent, please call 1-800-328-0211.**

Model: \_\_\_\_\_

Serial number: \_\_\_\_\_

Type of spray gun: \_\_\_\_\_

Serial number: \_\_\_\_\_

Is your equipment:

Single phase: \_\_\_\_\_ Three phase \_\_\_\_\_

What is the inbound voltage  
to your equipment: \_\_\_\_\_

Temperature setting ISO: \_\_\_\_\_

Temperature setting POLY: \_\_\_\_\_

Temperature setting HOSE: \_\_\_\_\_

### **For Air Powered Systems:**

Air compressor size: \_\_\_\_\_

CFM generated: \_\_\_\_\_

Pressure at the system:

Hydraulic \_\_\_\_\_ Pneumatic \_\_\_\_\_

Dynamic fluid pressure:

ISO \_\_\_\_\_ POLY \_\_\_\_\_

Spray gun chamber size: \_\_\_\_\_

Material being sprayed: \_\_\_\_\_

Viscosity: ISO \_\_\_\_\_ POLY \_\_\_\_\_

Approximate material temperature: \_\_\_\_\_

For Your Reference



**Date Purchased** \_\_\_\_\_  
**Distributor** \_\_\_\_\_  
\_\_\_\_\_  
**Contact** \_\_\_\_\_  
**Phone** \_\_\_\_\_  
**E-mail** \_\_\_\_\_

GlasCraft manufactures a complete line of polyurethane foam and polyurea coating spray systems. If your application is in-plant or a field contractor - GlasCraft has a system package to meet your requirements.

***GUARDIAN - AIR POWERED / A5 & A6 SERIES EQUIPMENT***

- . 6000 OR 12000 WATTS OF HEAT
- . 1600, 2200, OR 3000 PRESSURE SET-UPS AVAILABLE

***MH, MH II, & MH III HYDRAULIC POWERED SYSTEMS***

- . UP TO 45 LBS / MINUTE OUTPUT
- . EXCELLENT PERFORMANCE AND RELIABILITY

***GUARDIAN MMH - MOBILE MODULAR HYDRAULIC SYSTEMS***

- . SPECIFICALLY DESIGNED FOR ANY TYPE OF SPRAY RIG
- . GIVE COMPLETE UTILIZATION OF FLOOR SPACE IN MOBILE RIG

***PROBLER P2 SPRAY GUN***

- . IMPINGEMENT MIX / AIR PURGE
- . OPTIONAL NOZZLE FOR SPRAYING STUD WALLS, POURING & STREAM JET

For more information concerning any of these GlasCraft products,  
contact your local authorized GlasCraft distributor or visit [www.glascraft.com](http://www.glascraft.com)

Quality and Performance...

GENUINE GLASCRAFT

**Glas** **Craft**

DISPENSING EXCELLENCE



[www.glascraft.com](http://www.glascraft.com)

**313266F**

**ENG**

Original instructions. This manual contains English.

**A GRACO COMPANY**

GRACO INC.  
P.O. BOX 1441  
MINNEAPOLIS, MN 55440-1441

Phone	612-623-6921
Toll Free	1-800-328-0211
Fax	612-378-3505